

[圧力]の種類を以下に示す。0, 100  
 Selection of pressure sensor types, to be entered in "[圧力(Pressure)]"  
 as the model, is shown as follows: 0, 100

[電源]の種類を以下に示す。BT、AC、DC  
 Selection of power supply types, to be entered in "[電源(power supply)]"  
 as the model, is shown as follows: BT, AC, DC

BT, DCのみCEマーキング有  
 CE marking is applied for BT and DC types only.

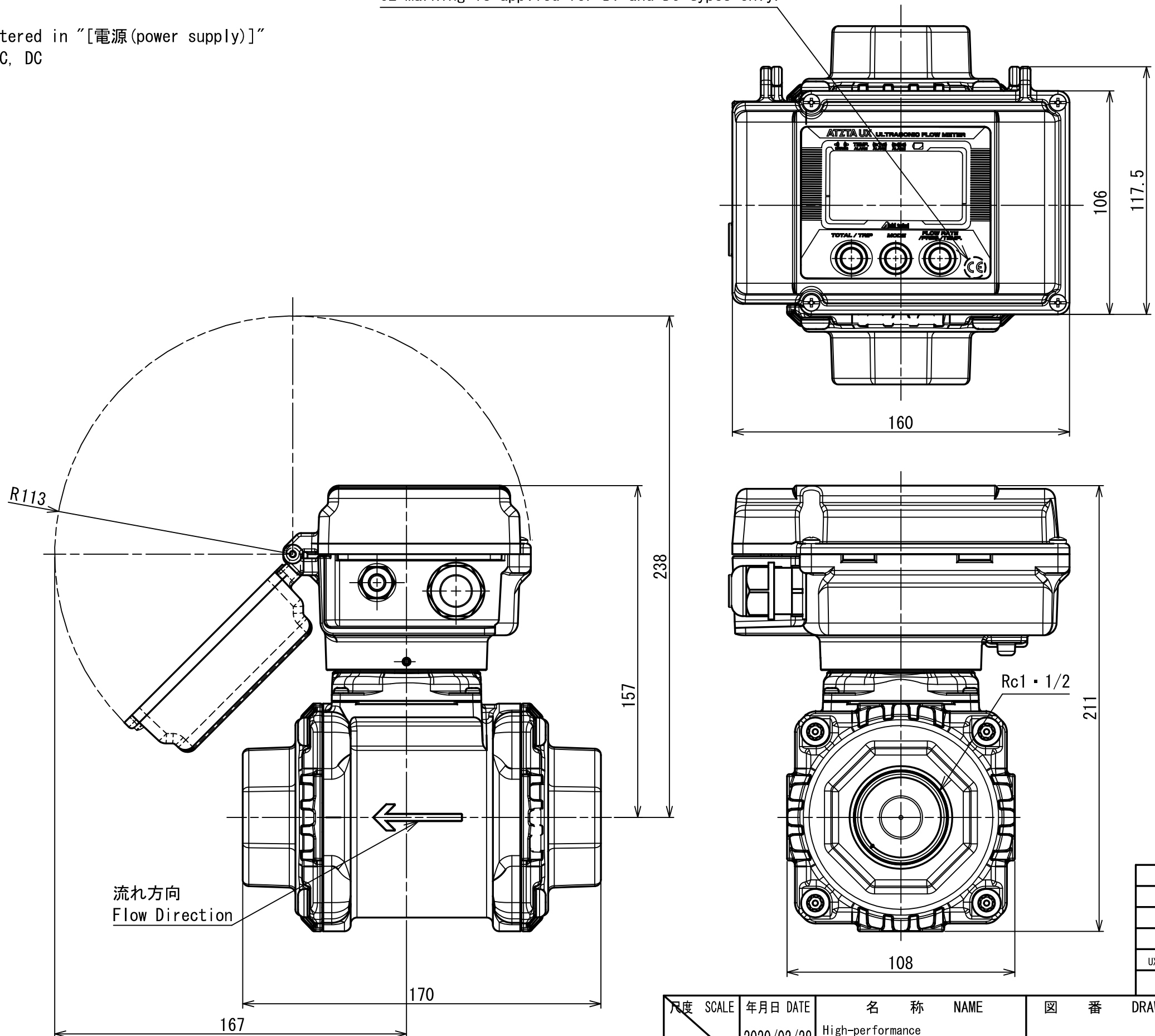

No	D1	D2	C
1			
2			
3			
4			
5			
6			
7			
8			
9			
10			
11			
12			
13			
14			
15			
S			

UX40-[圧力][電源]-U
型 式
MODEL

尺 寸	SCALE	年 月 日	DATE	名 称	NAME	図 番	DRAWING NUMBER
		2020/02/28		High-performance Ultrasonic Flowmeter for Fuel Gas		UX40-[圧力][電源]-U	