

[圧力]の種類を以下に示す。0, 100
 Selection of pressure sensor types, to be entered in "[圧力(Pressure)]"
 as the model, is shown as follows: 0, 100

[電源]の種類を以下に示す。BT、AC、DC
 Selection of power supply types, to be entered in "[電源(power supply)]"
 as the model, is shown as follows: BT, AC, DC

BT, DCのみCEマーキング及びUKCAマーキング有
 CE marking & UKCA marking is applied for BT and DC types only.

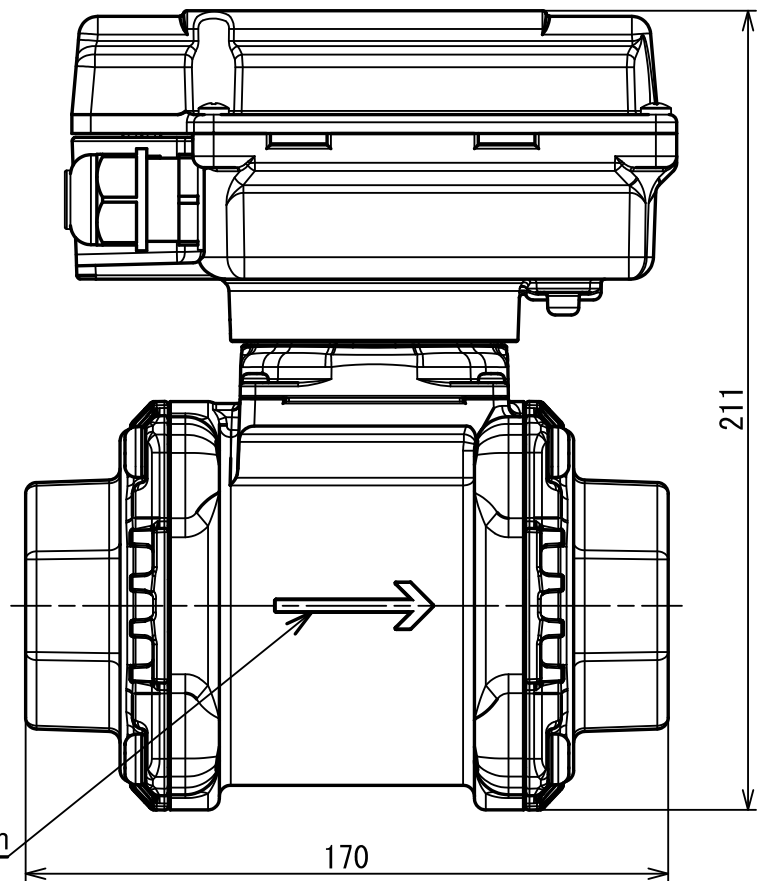
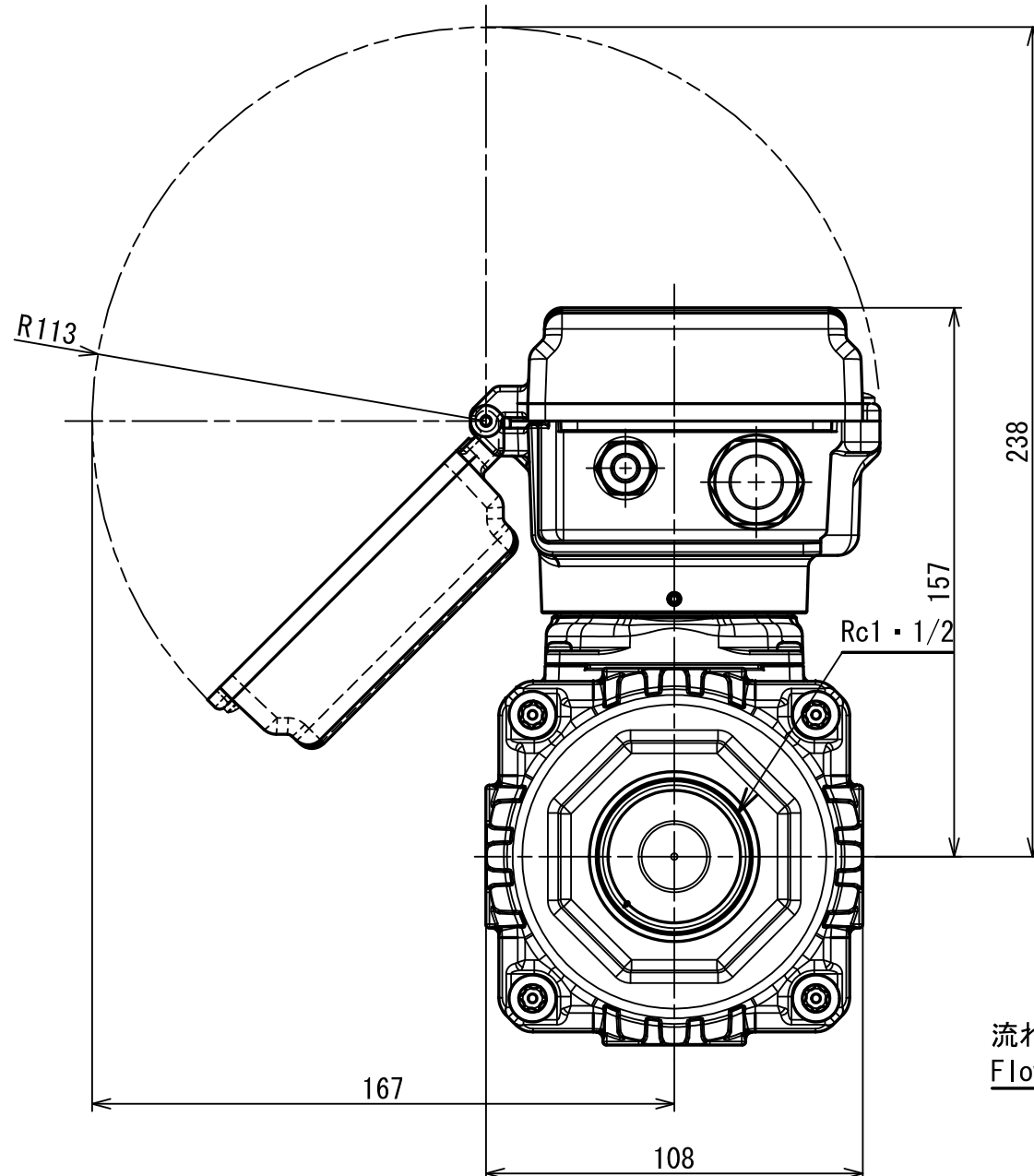
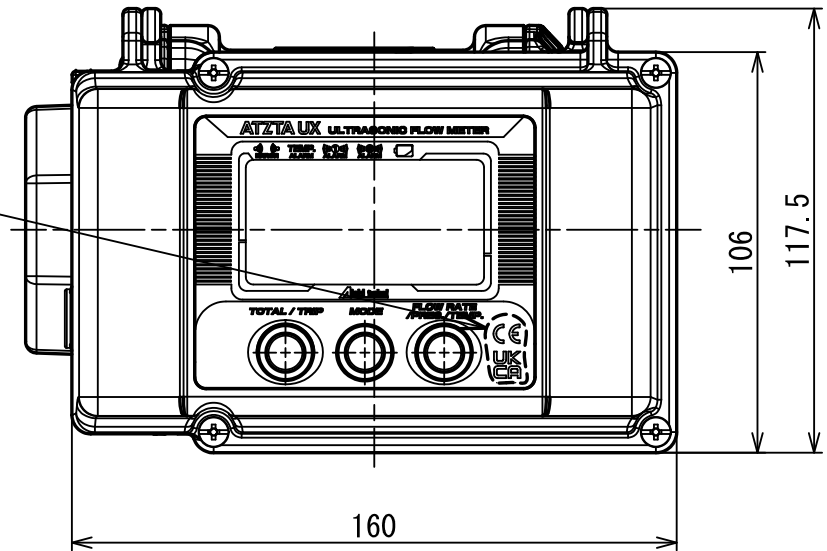

No	D1	D2	C
1			
2			
3			
4			
5			
6			
7			
8			
9			
10			
11			
12			
13			
14			
15			
S			

UX40-[圧力][電源]-L
型 式
MODEL

尺 寸 SCALE	年 月 日 DATE	名 称 NAME	図 番 DRAWING NUMBER
	2022/11/25	High-performance Ultrasonic Flowmeter for Fuel Gas	UX40-[圧力][電源]-L